

HOKITIKA BEACHFRONT
SEA EROSION

August 1984

(FINAL VERSION)

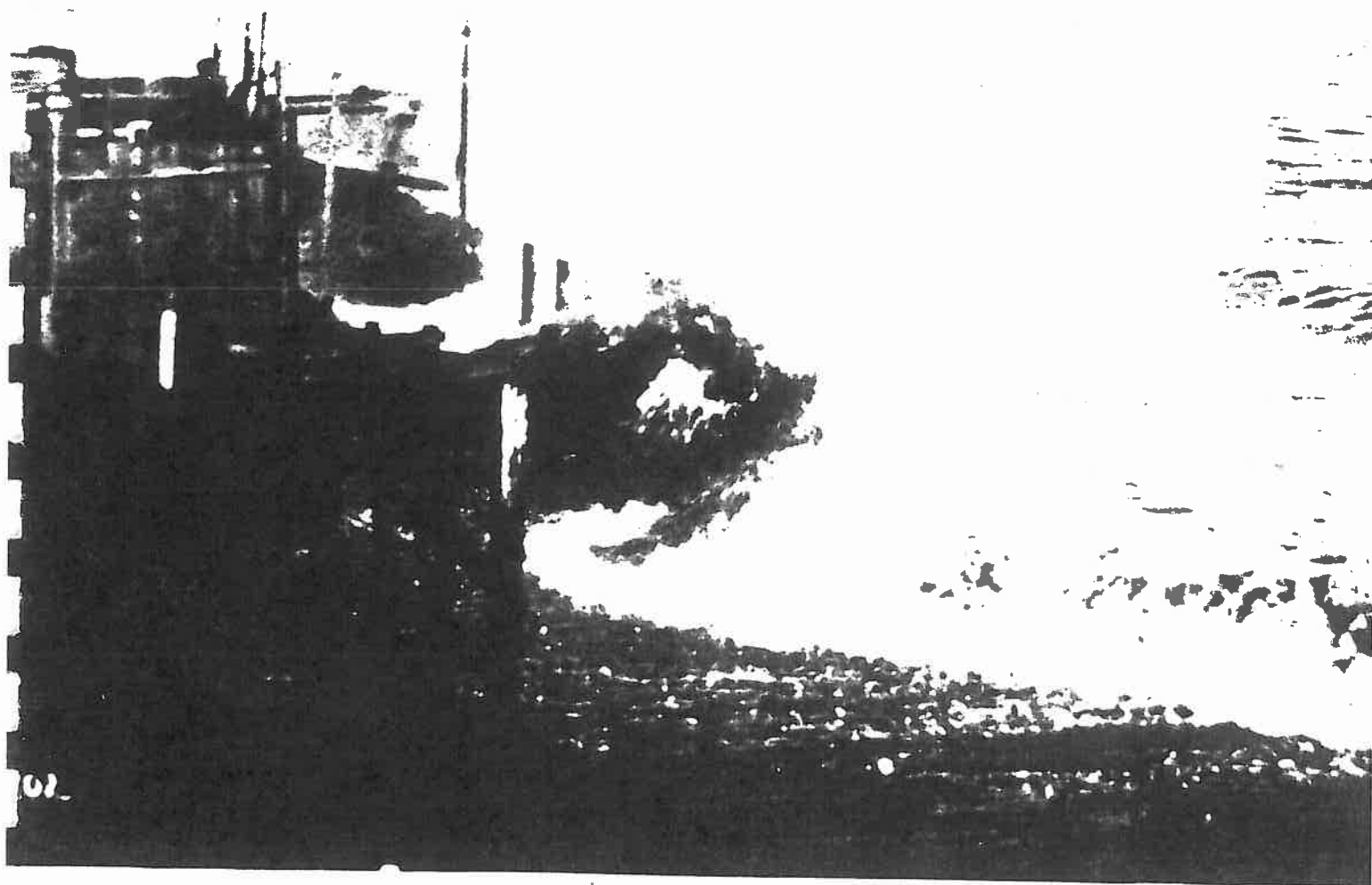

CONTENTS

Con Hok. Ltr
Hokays Ltr.

<u>SECTIONS</u>	<u>PAGE</u>
1. <u>INTRODUCTION</u>	1
2. <u>DAMAGE TO FORESHORE</u>	2
3. <u>COASTAL PROCESSES - METEOROLOGICAL DATA</u>	3
4. <u>TIDES AND CURRENTS</u>	3
5. <u>HISTORIC SHORELINE MOVEMENTS</u>	3
6. <u>SAND MOVEMENT</u>	4
7. <u>SAND MOVEMENT - LITTORAL TRANSPORT</u>	4
8. <u>SEDIMENT DATA</u>	4
9. <u>DETAILS OF PROPOSAL</u>	
(a) Construction materials	4
(b) Backfill material	4
(c) Position	5
(d) Effect of Works	5
(e) Estimate of Cost of Construction of sea wall	6
10. <u>ENVIRONMENTAL ASPECTS</u>	7
11. <u>RECREATIONAL SIGNIFICANCE</u>	7
12. <u>TOWN AND COUNTRY PLANNING ASPECTS</u>	8
13. <u>ECONOMIC JUSTIFICATION</u>	8

14.	<u>ALTERNATIVES</u>	
	(a) Do Nothing	9
	(b) Erect a sea wall on present beach sea line	9
	(c) Erect a sea wall on back of Revell Street properties	9
15.	<u>FINANCE</u>	10
16.	<u>DESIGN</u>	10

2nd August, 1984

The Chairman,
National Water and Soil Conservation Authority,
P.O. Box 12-041,
WELLINGTON.

Dear Sir,

FORESHORE PROTECTION - HOKITIKA BOROUGH

The Hokitika Borough Council are very concerned over the coastal erosion which is occurring now at a very rapid pace and threatening the township.

In June 1983 the Borough Council requested the Board to investigate a protection scheme for the township and apply for a grant from the National Authority. Over the past 12 months regular monitoring of the beach erosion has been carried out and the yearly cyclic behaviour established.

The erosion rate over the past year has been of the order of 7.5 metres.

The Borough Council at an on-site meeting on 4 July requested the Board to complete the engineering proposal and obtain a grant from the National Authority to enable works to be undertaken. I submit the following application to the National Authority for grant assistance.

1. INTRODUCTION

The Hokitika Borough Township is situated on the coastal strip immediately to the north of the Hokitika River. The Commercial portion of the town is located on the foredune with rail and highway being located on the edge of the secondary dune. The Government Building, Railway Station and yards, and Post Office are located in the low lying area between the foredune and the secondary dune.

The attached cross-sectional plan 906/202 illustrates the saucer like nature of the basin in which the Township is located.

The real problem which gives rise to the protection proposal is that the sea at the present time is rapidly eroding away the foredune - the edge of the saucer like basin. With the erosion of this edge the sea will spill across into the basin in which the township is located. The life of the town depends on sheilding the foredune from erosion.

Attached find photographs of 1914 erosion and protective works together with photographs of present erosion taken 4 July 1984.

The beach is unprotected at the present time except for some rock at the extreme end of the spit. This work was placed in January 1979. During heavy seas the waves break over the spit into the river.

2. DAMAGE TO FORESHORE

Over the past 2 years the sea has been encroaching rapidly into the foredune. Over the past 12 months the encroachment was of the order of 7.5 metres.

In January 1979 rock protection work was placed at the southern end of the spit. This rock work appeared to be very successful in that the beach built up rapidly. With the present erosion cycle, however, the seas have got around the back of the rock work and the rock is now a sea wall out from the spit.

The size of rock used varied from 4 to 8 tonne and has withstood the sea onslaught to date. Rock placed previous to 1979, some 20 metres further seaward has slumped due to scour so that it is only visible at low tide.

The 1914 protective works consisted of rows of timber piled groynes out at right angles to the shoreline. These groynes were planted and backed with scrub. See photo 'Ben Thiem Collection' dated 10 May 1914 attached. They appear to have worked very successfully as the beach aggraded rapidly. Whether or not this aggradation was due to the groynes or not is debatable. I am of the opinion that limited aggradation can be attributed to the groynes. The bulk of the aggradation was cyclic in nature. Maybe a 80 year cycle.

In addition to the groyne protection works in 1914, a sand bag revetment wall was constructed along the beach frontage. One of the photographs shows the bag revetment wall consisting of at least 5 rows of bags on a slope of 2 to 1 or flatter, and plenty of scrub - (cut manuka) is in evidence, suggesting that the scrub formed a near vertical wall at the top of the bag layer.

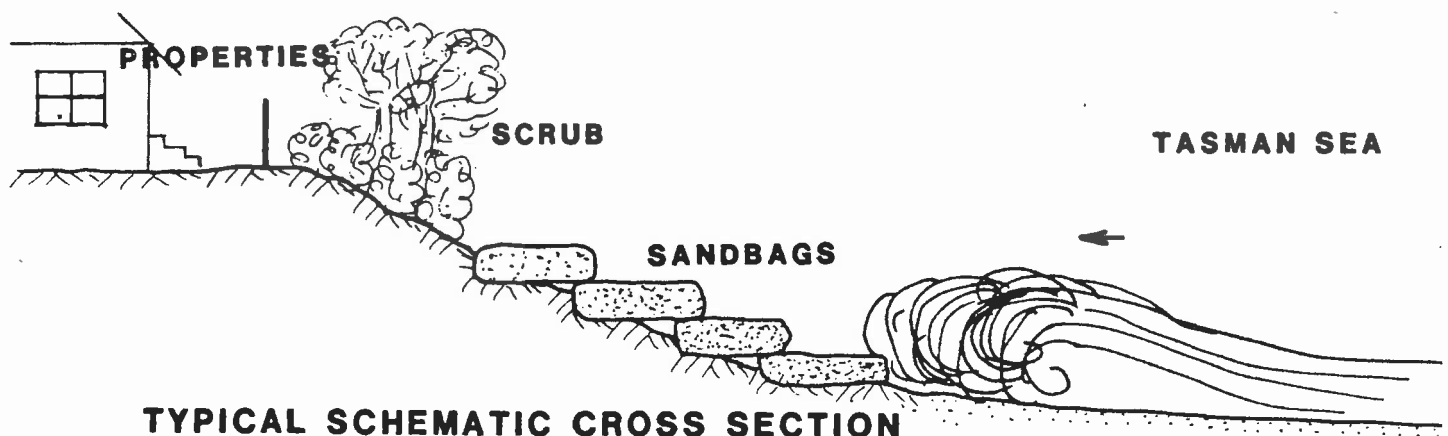

The erosion up until 1914 appears to have been spread over at least 8 years. When Mr Massey the then Prime Minister, advised of Government authorisation of a grant of 500 pounds on a pound for pound basis, the newspaper report of this goes on to say: "The position must be regarded as serious when it is borne in mind that in eight years the sea has encroached between one hundred and fifty and two hundred feet."

The present erosion rate appears to be of the same order as occurred in the years 1906 to 1914, i.e. 7.5 metres per year. The storm of the 9th April 1914 caused the beach to be eroded by 15 metres. This is possible for a similarly size storm today.

The sea has 20 metres to go as at 14 June 1984 to reach residential and other buildings.

3. COASTAL PROCESSES - METEOROLOGICAL DATA

The most serious storms are from the Northwest. On 9 April 1914 when the beach eroded 15 metres overnight the newspapers record: 'A fierce nor-west gale hit the town and a tremendous sea raged on the water front.' In winter months whenever north west gales occur the erosion rate has been observed to increase. With southwest winds aggradation occurs. It is difficult to measure the effect of the erosion rate resulting from gales from different quarters as the wind usely changes from North West to South West in the cause of the event.

4. TIDES AND CURRENTS

Mean spring tide was measured on the 13 July at 1.4 metres (Land and Survey Department datum). The top of the proposed wall is to be at 5.3 metres and base between -0.3 and 2.5 metres. Tide levels have been calculated from the nautical almanac:

- mean high water spring	+1.4
- mean high water neap	+0.9
- mean low water neap	-0.3
- mean low water spring	-0.7
- mean sea level	+0.3

Currents:

There is a northerly drift of 1 knot with a local secondary southerly current along the beach frontage from Town Belt North, south, to the river mouth.

The storm surges are such that seaweed, drift wood and other debris is thrown across the road along the sea frontage. Level 5.3.

5. HISTORIC SHORELINE MOVEMENTS

Attached find aerial photograph with historic shoreline movements shown superimposed on it.

The shoreline movements can be described as cyclic - The long term (80 year plus cycle) and the yearly cycle.

The long term cycle in 1914 caused erosion such that the top of the beach embankment was along the back of the Revell Street premises. This erosion cycle has some 60 metres to go in the northern area between Stafford and Hamilton Streets, but to the south it is now on the actual 1914 erosion line.

The yearly cycle is at present advancing some 7.5 metres per year towards the township between Stafford and Hamilton streets.

6. SAND MOVEMENT

The annual beach cycle is at the present time encroaching inshore by 7.5 metres per year. In winter months there is a degradation of 2 metres and in summer an aggradation of 2 metres making a net change in beach level of 4 metres between summer and winter.

The long term beach profile appears from old photos to have been as shown on typical cross-section at Stafford Street. See page 4 over.

7. SAND MOVEMENT - LITTORAL TRANSPORT

The longshore transport of beach sediment is of the order of 10 million cubic metres per year. Reference R.M. Kisk. A large proportion of the sediment coming from the Hokitika River. Due to the spit formation out from the Hokitika river mouth the natural feed of beach material tends to be cut off and hence a depletion cycle sets in along the township frontage.

8. SEDIMENT DATA

A summary of sieve analysis is to be forwarded when laboratory test results received.

9. DETAILS OF PROPOSAL

(a) Construction materials

It is proposed to place a two rock thick rock revetment wall along the beach front from the existing rock work at the southern end up to Stafford Street at the north end: a distance of 1000 metres. The wall to be constructed on a 1.5 to 1 batter with the toe excavated down into the beach to provide at least one metre depth of covering over the toe. Facing rock size to be in the range 4 to 6.75 tonne. This rock to be laid two rocks deep on top of a 500mm layer of 350 to 550 kilogram quarry rock or tailings. See plan Page 4 (b) over.

The 350 to 500 kilogram rock to be laid on a bull-dozed bed covered with coarse beach gravels.

This method was used at the south end of the beach at Hokitika in 1979 and on the Cobden beach in 1969. The quantity of rock used was based on 140 cubic yards per chain (14 tonnes per metre) but on a recent inspection of the jobs there appeared to be at least 18 tonnes per metre. In both these jobs the rock walls withstand the sea forces remarkably well. At Cobden the beach material was far coarser than the Hokitika sands and a secondary layer was not used.

(b) Backfill material

It is proposed to push the beach material up with a bulldozer to form an embankment on which to lay the rockwork. Any additional backfill material required will be carted in from up river or from shingle pits to the north.

ORIGINAL SCALE OF INCHES

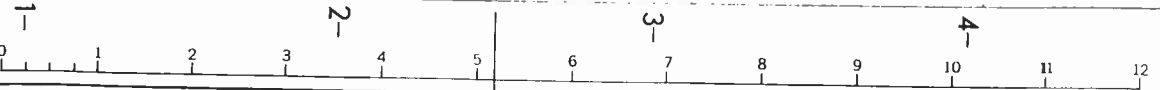

SURVEYED	W MOEN
DRAWN	W MOEN
COMPUTING	W MOEN
TRACED	W MOEN
CHECKED	J McF H

AMENDMENTS	
	JULY 1983
	JULY 1984

SCALES	
DATUM	LAS MSL
	LYTELTON

WESTLAND CATCHMENT BOARD
HOKITIKA BEACHFRONT
 Typical Cross section

Engineer	19
REFERENCE	Ln's 154,165, 172,173
No.	906
	202
	A2

CROSS SECTION ON STAFFORD STREET : MAIN HIGHWAY TO SEA

SCALES : HORIZONTAL : 1:1000
 VERTICAL : 1:100

DATUM -2.00 METRES	REDUCED LEVEL	DISTANCE
	0.00	
	2.833	
	88.8	3.233
	123.5	2.900
	236.5	2.661
	298.5	3.661
	364	4.907
	374	4.792
	387.5	6.122
	398.5	8.622
	400.5	8.682
	403.5	7.12
	405	8.210
	412	7.224
	416.5	1.797
	431.5	0.437
	458.5	-0.833

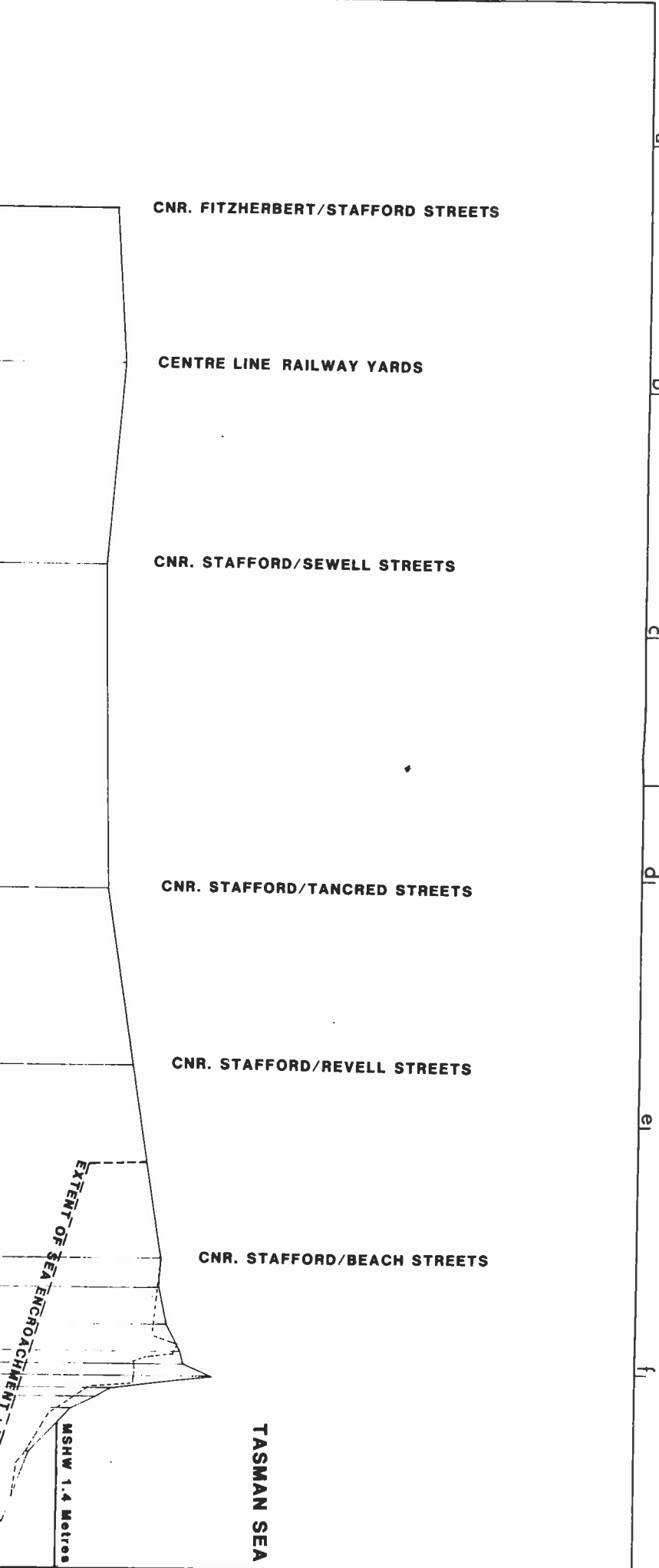

a
b
c
d
e
f

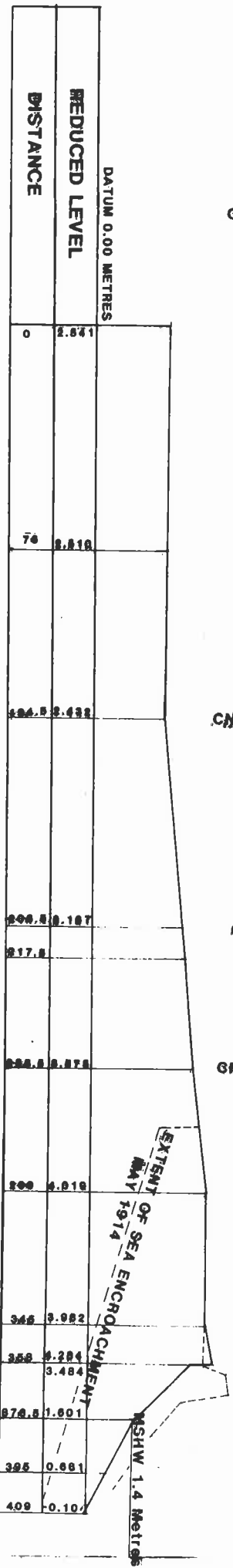

CNR GIBSON QUAY/SEWELL STREET

CNR CAMP/TANCRED STREETS

CNR CAMP/WHARF STREETS

CNR CAMP/REVELL STREETS

CNR CAMP/BEACH STREETS

TASMAN SEA

EXTENT OF SEA ENCROACHMENT
MAY 1914

NSHW 1.4 Metres

CROSS SECTION ON CAMP STREET : SEWELL STREET TO SEA

SCALES : HORIZONTAL : 1:1000
VERTICAL : 1:100

BY BOEN	JULY 1983	SCALES	WESTLAND CATCHMENT BOARD HOKITIKA BEACHFRONT Cross Section : Southern End	Engineer	19	Supt	1
BY BOEN	AUGUST 1984	DATUM 143 MSL LYTELTON		REFERENCE SPS 164, 165, 171, 172, 163	No	306/206 A2	
AMENDMENTS							

SCALES

a

b

c

d

e

f

g

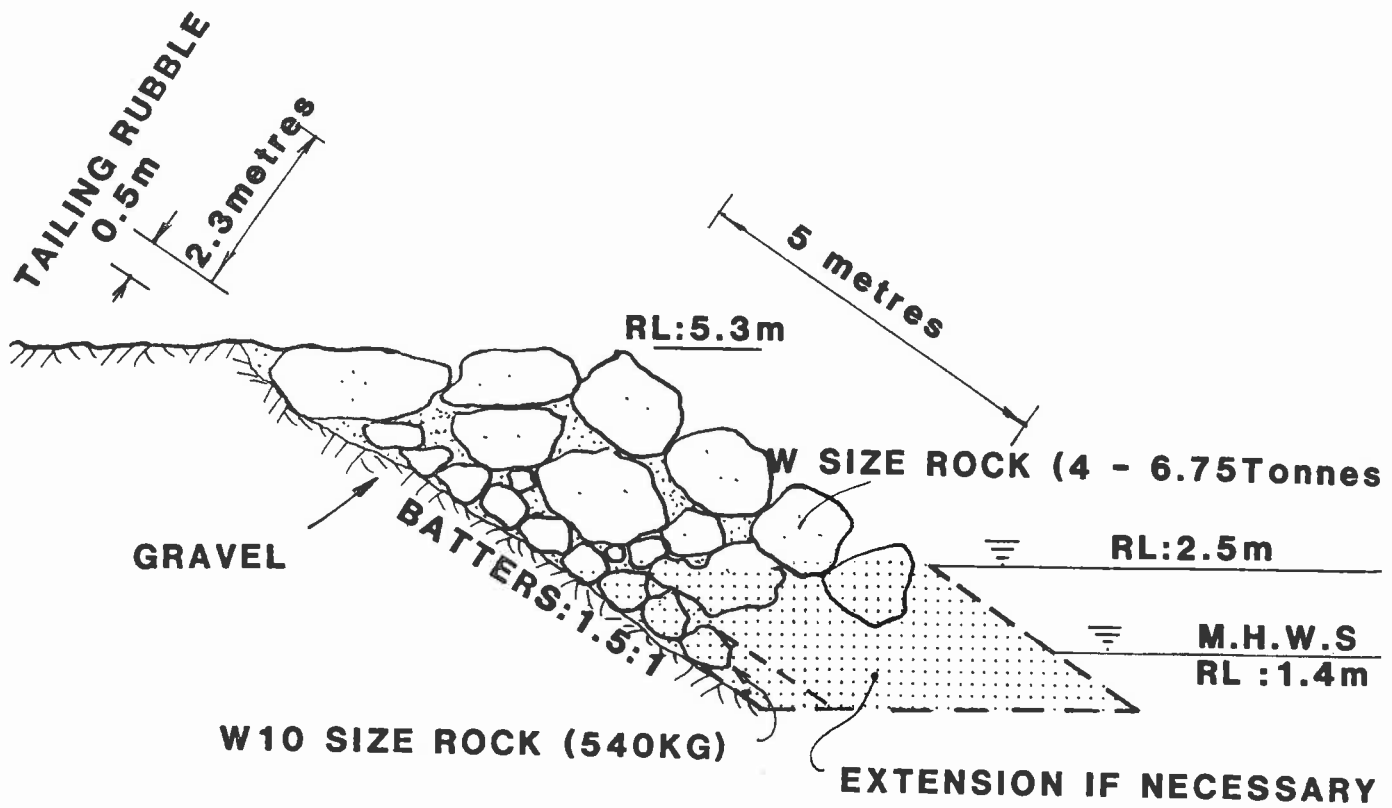

TYPICAL CROSS SECTION THROUGH PROPOSED BANK

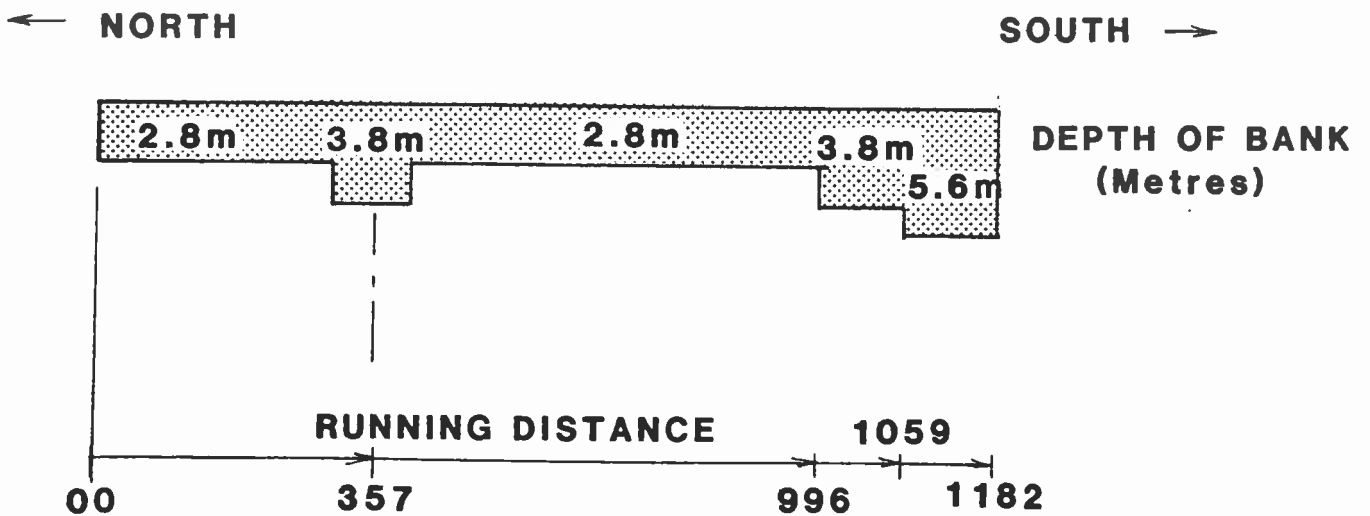

SCHEMATIC LONG SECTION

(c) Position

The attached Plan 906/202 Appendix 5 shows the position of beach profiles as at: 1867, April 1914, 1958 and June 1984.

Generally, in respect of the beach between Camp Street and Stafford Street, the sea can be said to have come in 20 metres from between 1867 and 1914, retreated 60 metres between 1914 and 1958 and came in 10 metres since 1958.

The current position being that the beach front is some 50 metres seaward of the 1914 line.

Should a wall be constructed along the present beach line the vertical height of wall needed at the present time will taper from 5.6 metres at the southern end to 2.8 metres at the northern end 'Stafford Street'. With continued erosion the height of wall needed at Stafford Street could well be 5.6 metres too in the next few years. The 1914 beach profile plotted on the cross-section at Stafford Street indicates that a 6.5 metre wall could be needed in the ultimate.

The cost of a 6.5 or even a 5.6 vertical height wall is far beyond the means of the Borough, and this proposal proposes that the minimal height necessary at the present time only be built. Should the beach profile drop in the future then the scheme provides for extension of the base of the wall down in stages. At least one metre beach coverage should be provided over the toe of the wall at all times.

(d) Effect of Works

The effect of the works will be to halt further erosion of the shore line. The works proposed are not designed to attract aggradation of beach materials but past experience at the south end of the Hokitika beach and at Cobden has shown that aggradation has occurred following placement of the rock.

The placement of a wall along the southern portion of the Hokitika sea frontage will have little affect on the northern portion, as the beach nourishment material comes largely from river source rather than depletion of the beach. At the present time the net yearly deficit along the 1000 metre length of Hokitika foreshore is of the order of 20,000 cubic metres, one fiftieth of the coastal movement of 1 million cubic metres per year.

From the beach profiles it is evident that the bulk of the erosion is occurring at the spit head to the south, tapering off to the north, so that at Stafford Street cross-section aggradation of the beach between high and low tides appears to be occurring. However when the erosion of the beach frontage is taken into account there is a net loss.

The explanation for this is that the spit at the Hokitika river mouth is diverting the beach nourishment material out to sea in an area around the large sand bed. The currents bring this nourishment back inshore north of Stafford Street. See photo over Page 6(a).

At the end of the proposed sea wall a return wall will be built to prevent the sea getting in behind it.

There will be a back-wash effect from the wall. Calculations indicate a reflection coefficient of up to 0.36. The effect of this will be to reduce wave forces considerably, but may cause slightly increased scour at the toe of the wall.

It is not envisaged that the construction of the wall will influence to any noticeable extent the current and drift patterns.

(e) Estimate of Cost of Construction of Sea Wall

1100 Metres in length

Basic dimensions:

Vertical Height 2.8 metres
 Thickness 2.3 metres
 Sloping Height 5 metres
 Batter 1.5 to 1

Where toe of wall does not have 1 metre of beach cover wall to be extended down on 1.5 to 1 batter until the 1 metre cover obtained.

Excavation

\$

D8 \$120 per hour
 20 metres per hour
 1000 metres @ \$6 6,000

Rock ex Camelback Quarry

11.5 cubic metres/metre @ \$18
 = \$207/metre
 (\$10 per tonne rock = \$18 per cubic
 metre loose)
 quarry charge \$2.25 per tonne
 cartage \$7 per tonne
 placement 0.75 per tonne
 1000 metres @ \$207 207,000

Tailings ex Kaniera

As secondary layer on which to laid
 large quarry rock.
 \$13 per cubic metre
 2.5 cubic metres/metre
 1000 metres @ \$32.50 32,500

Sand bar, north of Hokitika River mouth, photo taken 22.7.1981

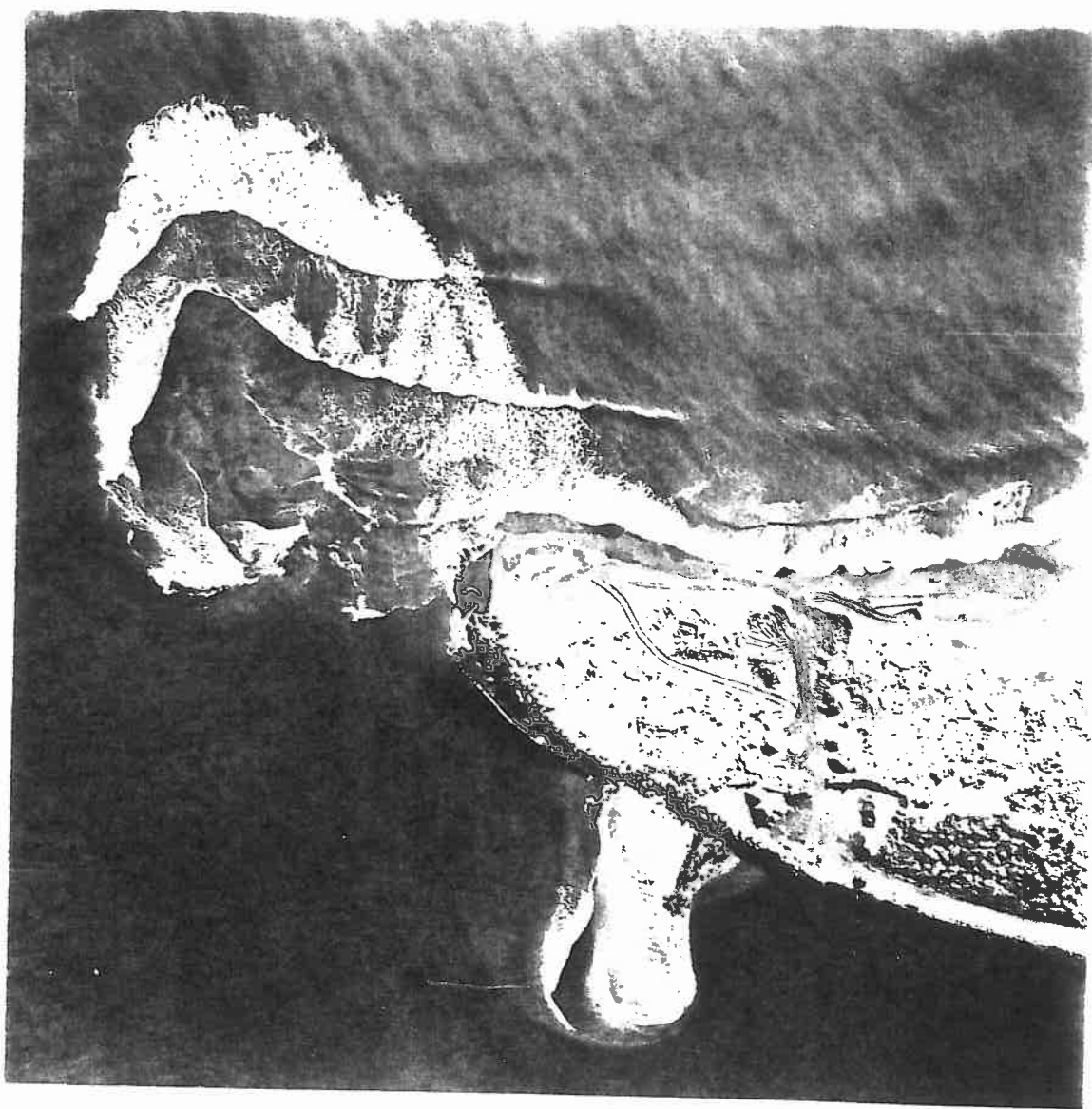

Extending wall down 1 metre Cross-sections 996 and 357 200 metres @ \$250 = (\$89) 2.8	17,800
Extending wall down 2.8 metres cross-sections 1059 to 1182 122 metres @ \$250	30,500
Return wall at Stafford Street	<u>4,000</u>
	297,800
+ 5% Contingencies	<u>14,940</u>
	312,740
+ 20% Service Charge	<u>62,548</u>
	\$375,288
	=====
	SAY: \$375,000

10. ENVIRONMENTAL ASPECTS

In general it can be said that a sea wall is needed to protect and improve the environment of the beach.

The Internal Affairs Department have been consulted and have advised that 'they judge the environmental impact to be minimal and do not foresee any need for specific planning to protect wildlife or habitat values'.

The recreational aspects will be greatly improved, see item 11 below.

There will be no loss of historic interests by the erection of the wall. Historic buildings and sites will be protected by the erection of the wall.

The loss of vehicle access to the beach over the township frontage will not be detrimental to the environment. There are beaches to the north and south where vehicle access is available for firewood collection and other pursuits.

11. RECREATIONAL SIGNIFICANCE

The construction of the proposed sea wall will have significant recreational benefits.

- (a) It will enable the beach frontage behind the sea wall to be used for construction of permanent playing fields, car parks and sporting facilities.
- (b) Improvement of the visual appearance of the sea frontage. It has become a general tip head at present with various sorts of rubbish such as old sewer pipes, concrete, garden materials etc being tipped along the beach in an effort to halt the erosion.

Recreational Losses

Loss of gold prospecting on the beach face
 Loss of vehicle access for collecting shingle sand and firewood.

Overall there will be a marked recreational benefit.

The present uses are:

1. Shingle and sand extraction
2. Firewood source
3. Walking, running and general beach combing.

Only limited use is made of the beach for:

- Swimming
- Surfing
- Boating
- Fishing
- Picnicing

The construction of the seawall may encourage these uses.

12. TOWN AND COUNTRY PLANNING ASPECTS

The beach foreshore is designated for public and semi public purposes.

The land behind Beach Street between Stafford and Camp Streets is zoned for light industrial purposes.

The land behind the beach frontage, south of Camp Street is zoned for residential purposes.

Until the proposed wall is erected all the land on the seaward side of the 1914 beach line should be designated 'open beach' and at least a forty metre wide strip on the landward side of the 1914 beach line reserved for public access and sea wall protection purposes.

The proposed wall is to be built on public land.

13. ECONOMIC JUSTIFICATION

At the present time approximately 1 hectare of recreational reserve is lost per year.

Unless a sea wall is erected it is highly probable that the sea will cut back to at least the 1914 beach line, and the loss of property (1981 values) will be of the order of \$2,300,000.

There is no way of foretelling if the erosion will get to or halt at the 1914 line. Should the erosion get to the 1914 line then the vertical height of sea wall needed will be only 2.8 metres. But with loss of land and buildings valued at 2.3 million dollars there is no justification in letting this occur.

However, should a sea wall be erected at the rear of the properties fronting Revell Street there would be a loss of property valued at \$700,000, the height of sea wall needed would be of the order of only 3 metres. Being close to the 1914 beach line there will be every probability that it will survive sea intrusions as occurred in 1914.

14. ALTERNATIVES

(a) The 'Do Nothing' Alternative

The sea came in from 1867 to 1914 and went out again until 1958. It is starting to come back in again. Whether or not it will come right in to the 1914 line or not is debatable. The chances are that it will not come back in as far as it did in 1914.

The 'do nothing' alternative would be to repair minor sea intrusions as they occur by the placement of rock and rubble and maintain a sea frontage embankment to prevent wave overtopping and flooding of business area.

(b) Erect a Sea Wall on the Present Beach Line

The erection of a sea wall on the present beach line will halt erosion at this point provided the wall is maintained, topped up where necessary and sea wall extended down if beach levels drop so as to expose the toe of the wall.

There is an indication at present that a 5.6 metre vertical height wall will be required over the full Hokitika Beach frontage.

The cost of this type of wall is beyond the finances of the Borough and would require Government input beyond the presently proposed 30% grant rate.

(c) Erect a Sea Wall (if necessary) at the back of the properties fronting Revell Street

To raise a loan to build a sea wall along the back of the properties fronting Revell Street, and build the wall at the appropriate time if necessary.

The vertical height of wall necessary is envisaged to be only 2.8 metres. The loss of land (1981 values) would amount to \$700,000. Twice the value of the wall.

This wall being erected on the edge of a known beach envelope has a far greater chance of survival than a wall erected some 50 metres seaward.

Note:

The properties fronting Revell Street refer only to the Revell Street portions of the properties located between Revell and Beach Streets.

The Hokitika Borough have voted for the sea wall on the present beach line, option (b).

15. FINANCE

The Hokitika Borough Council are not financially endowed, and require Government monies to protect the township. What monies they need to find can only be raised by way of loan. Government assistance will be required to ensure that any loan required is forthcoming.

The normal grant rate for sea erosion is 30%. Due to the serious nature of the situation, and the lack of local finance to meet any grant monies allocated a 70% grant rate is proposed.

Grant	\$262,500
Local Share	\$112,500
	\$375,000
	=====

The interest payment alone on a loan of \$112,500 will be \$10,125 per year. This represents a rate of \$1 on every \$200 of capital value for the properties affected by the sea erosion. (Between Revell Street and the sea.)

Examples of rate increases for average valued properties are:

Domestic property value	\$10,000	rate increase	\$50
Commercial property value	\$100,000	rate increase	\$500

If interest and repayment are considered, these figures will be doubled.

16. DESIGNDesign of Revetment Type Sea Wall

Based on U.S. Army Coastal Engineering Research Centre, Shore protection manual.

(a) Design Wall Height

Note: Datum referred to is mean sea level Lyttelton. Mean high water spring at Hokitika is 1.4 metres.

The existing embankment has had to be lifted in places to a level of 5.3 metres to prevent excessive sea overflows into the township. After severe storms, Council staff remove drift wood and debris thrown up by the high seas. To keep costs to a minimum an embankment height to a level of 5.3 metres is proposed. The embankment can be topped up in the future should the Council require freeboard.

(b) Depth of Base of Wall

Over the past year cross-sections have been taken of the beach profile to establish the seasonal beach envelope. The survey has shown that there is a general build up of the beach in the summer months and a degradation in the winter months. The rise and fall ranging from plus 1.5 metres to minus 1.5 metres.

For design purposes the toe of the wall should be buried at least 1 metre into the beach. With the top of the sea wall at a level of 5.3 metres and the base at 2.5 metres the toe of the wall has 1 metre of cover over only about half its length. At the southern end the wall will need to be extended down to -0.3, and at cross-sections 357 and 1182 the extension down to 1.5 metres.

The maximum vertical height of the sea wall will be 5.6 metres. Slope height 10 metres.

(c) Wall_Profile

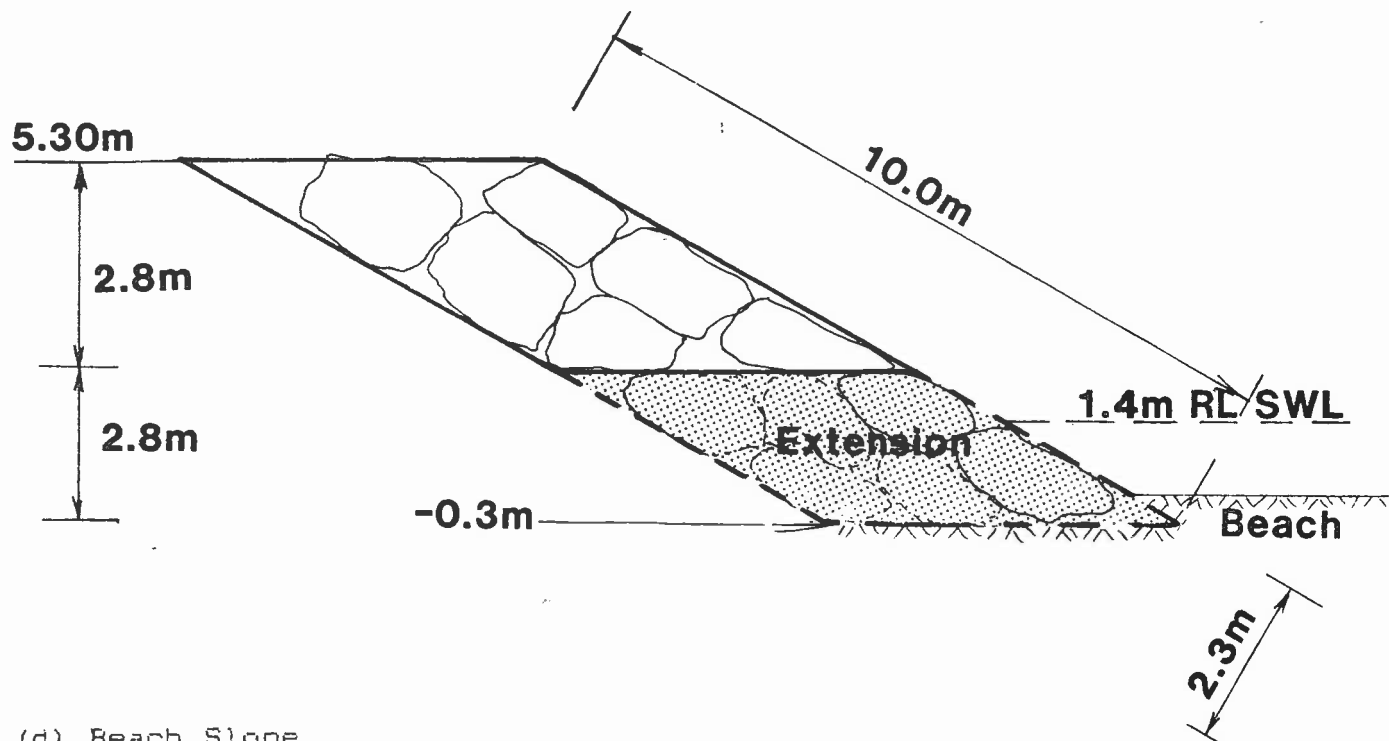

(d) Beach_Slope

Cross-sections indicate the beach slope is 1 in 18 $S = 0.056$

(e) Design_Wave_Height

The Science Centre, Christchurch, have been measuring wave characteristics offshore of Ngakawau, Westport and Carters Beach. The Ngakawau data is the most appropriate to use for Hokitika with its open coast line.

Wave Height:	10 year return period	7.8 metres
	20 year return period	8.4 metres
	50 year return period	9.3 metres
	100 year return period	10 metres

Design is based on 50 year return period, that is 9.3 metre wave.

Average wave period 7.5 seconds (35% frequency)
 Variation: 5.5 seconds (5% frequency)
 10.5 seconds (5% frequency)

Wave length

$$L_0 = \frac{gT^2}{2} = 1.56 T^2$$

Average Wave Length = 87.8 metres (288 ft.)
 Minimum Wave Length = 47.2 metres
 Maximum Wave Length = 172 metres

(f) Wave Breaking Height and Depth

Reference Figure 7 Page 7 - 9

$$S = 0.056$$

$$d_s = 1.7 \text{ metres (5.58 feet)}$$

$$T = 7.5 \text{ seconds}$$

$$\frac{d_s}{gT^2} = \frac{6.57}{32.2 \times 7.5 \times 7.5} = 0.00308$$

$$\frac{H_b}{d_s} = 1.58$$

$$H_b = 2.69 \text{ metres (8.82 feet)}$$

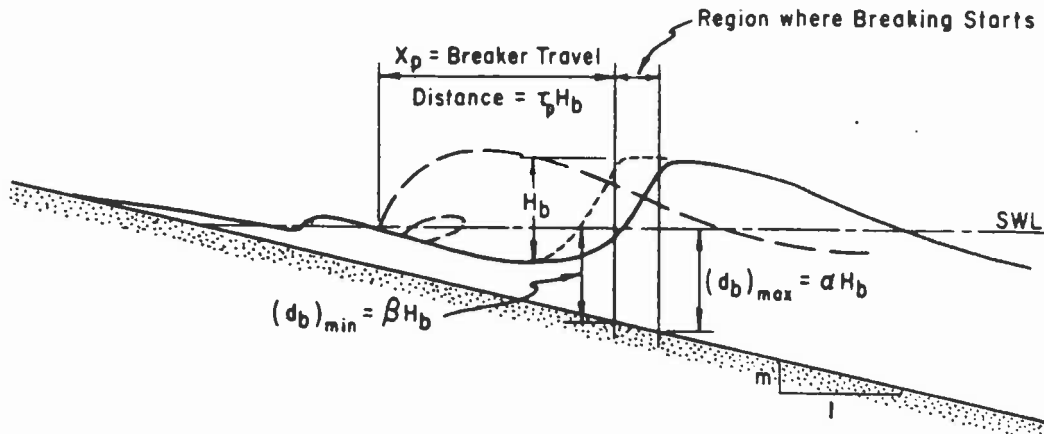
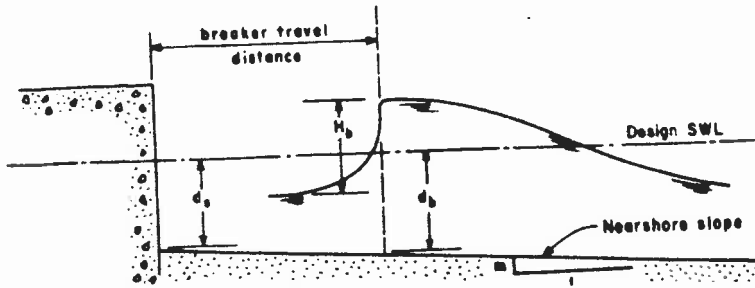

Need to design for breaking height 2.69 metres.

Breaking Depth

$$d_b = 1.28 H_b = 3.4 \text{ metres}$$

(g) Distance of Breaking Wave Offshore

Proposed Structure (Effect of Structure on Breaking has not been Considered)

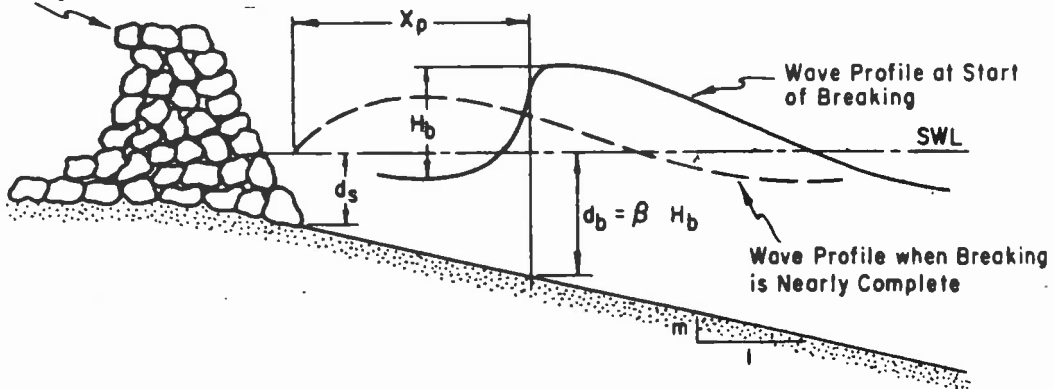

$$\frac{m}{1} = \frac{d_b - d_s}{X_p}$$

$$\frac{0.056}{1} = \frac{3.4 - 1.7}{X_p}$$

$$X_p = \frac{1.7}{0.056}$$

$$= 30.36 \text{ metres}$$

(i) Wave Reflection

P 2.117 - 2.120

X = x1 x2

Cotangent B = $\frac{1}{\tan B} = \frac{1}{0.056} = 17.9$

H₀ = 9.3 = 0.106
L₀ 87.8

from 2-63 x2 = 0.05

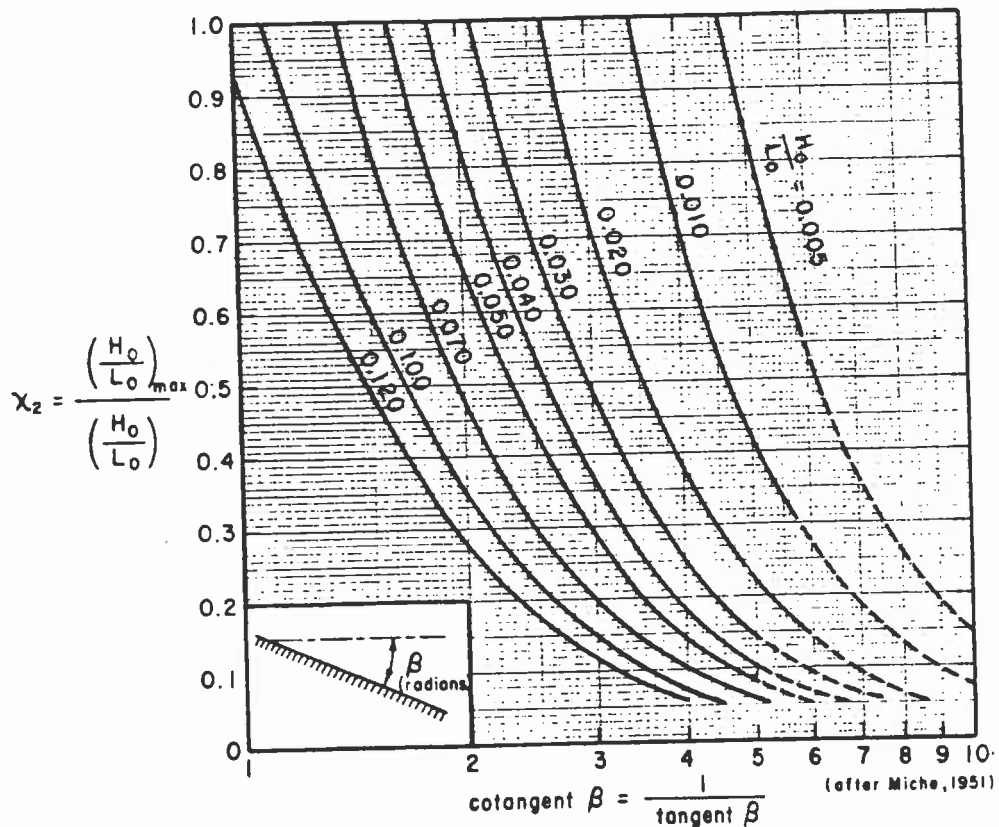

Figure 2-63. X₂ Versus Beach Slope for Various Values of H₀/L₀

x1 = 0.5

X = 0.025

Reflective Energy Factor 0.025

Crest Width

Recommended crest width 3 armour units wide
= 3.6 metres

actual width SQR 3.25 2.3 = 4 metres

Design_of_3_layer_wall

Reference P 7-193

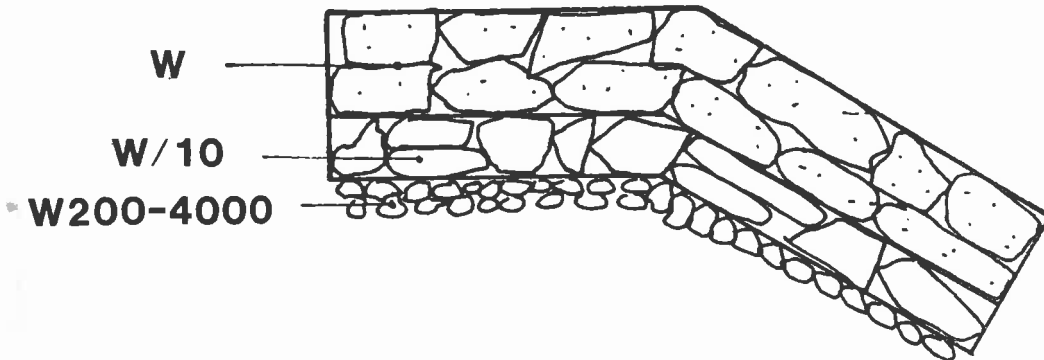

W = 5.4 tonnes
W/10 = 540 kilograms
W/200 = 27 kilograms

thickness 2.3 metres
thickness 0.5 metres
thickness 0.1 metres

HOKAUG.LTR

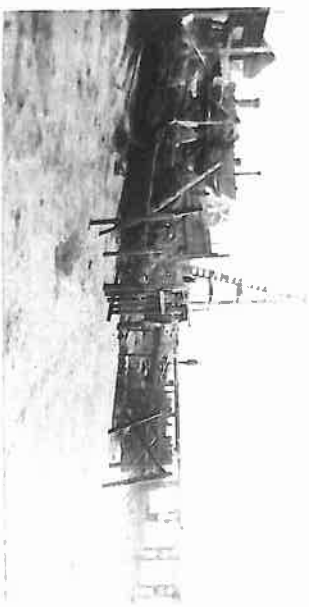

HOKITTIKA FORESHORE EROSION

10 May 1914

Ben Thiem Collection

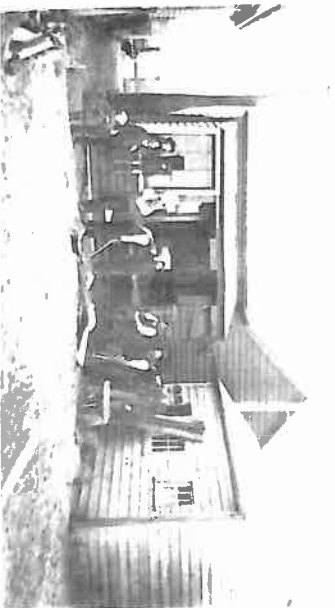

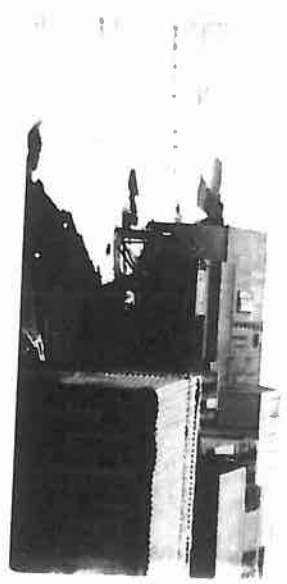

HOKITIKA FORESHORE EROSION

10 May 1914

Ben Thiem Collection

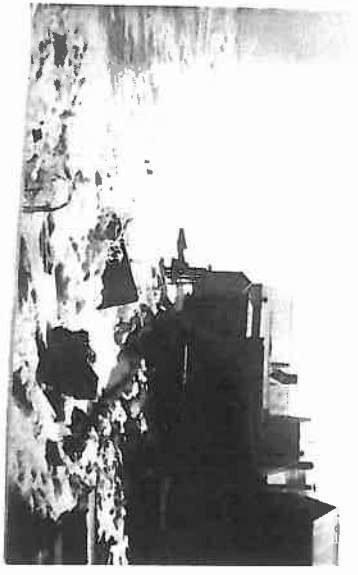

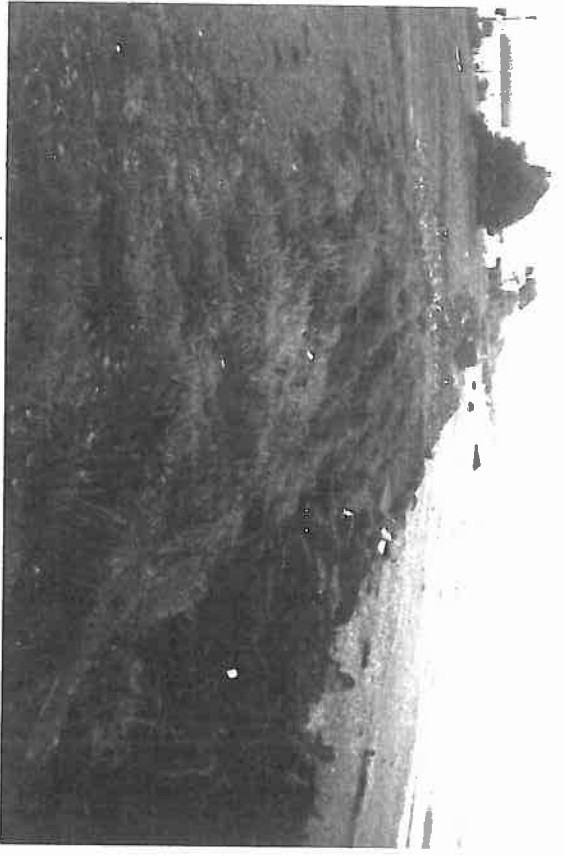

LOW TIDE 4 JULY 1984

SEA EROSION BETWEEN WELD AND CAMP STREETS



LOW TIDE 4 JULY 1984



LOW TIDE 4 JULY 1984

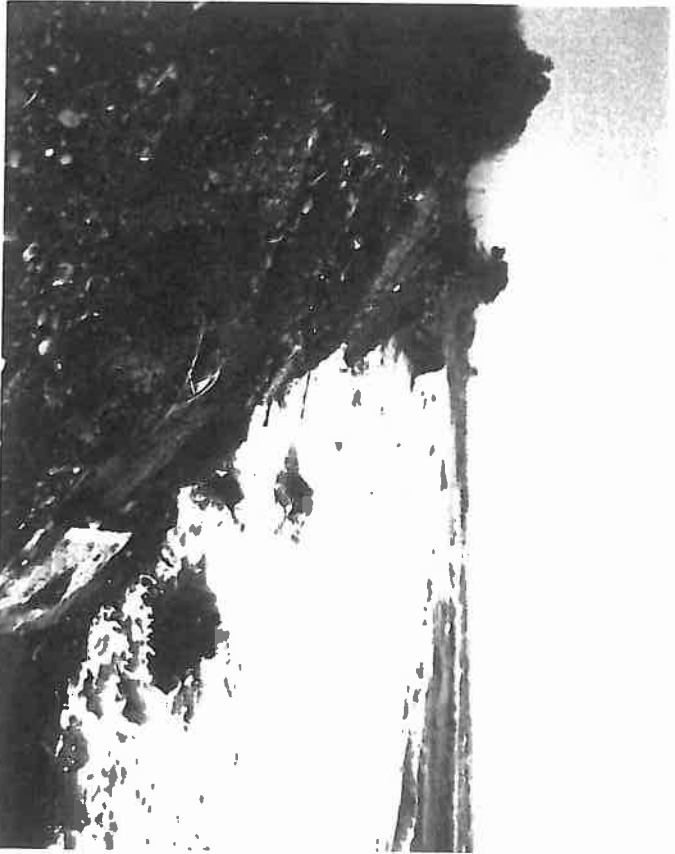

HIGH TIDE 30 JULY 1984

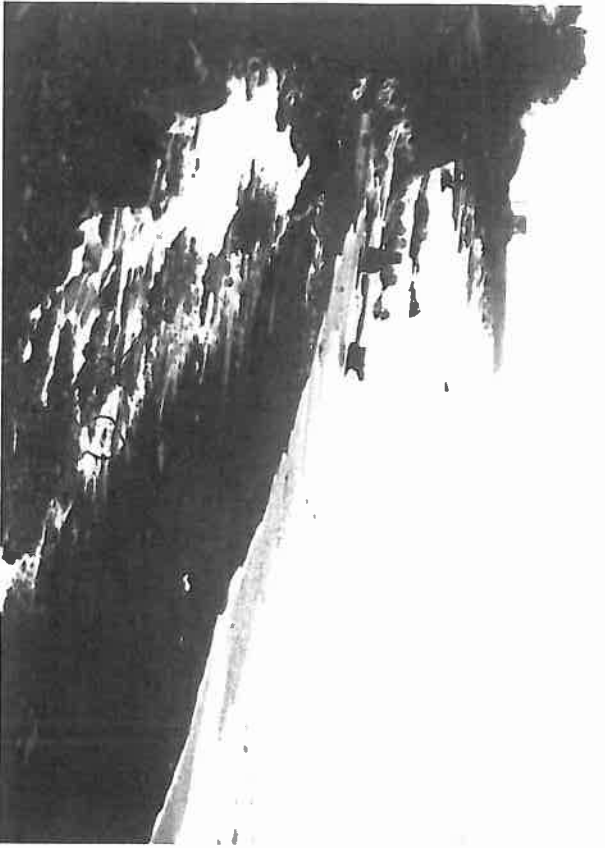

HIGH TIDE:30 JULY 1984

EROSION : SOUTH END



LOW TIDE 4 JULY 1984



LOW TIDE 4 JULY 1984

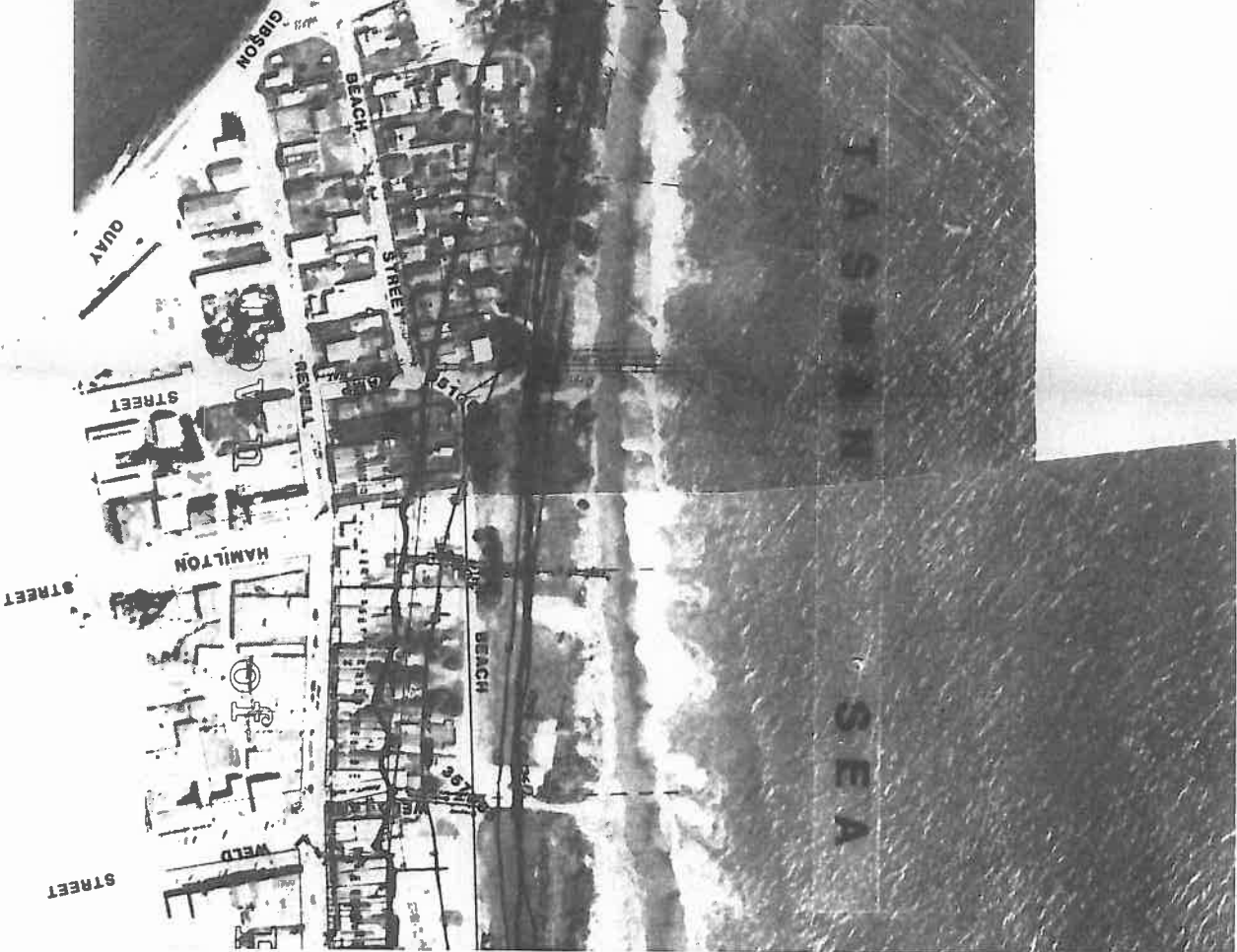
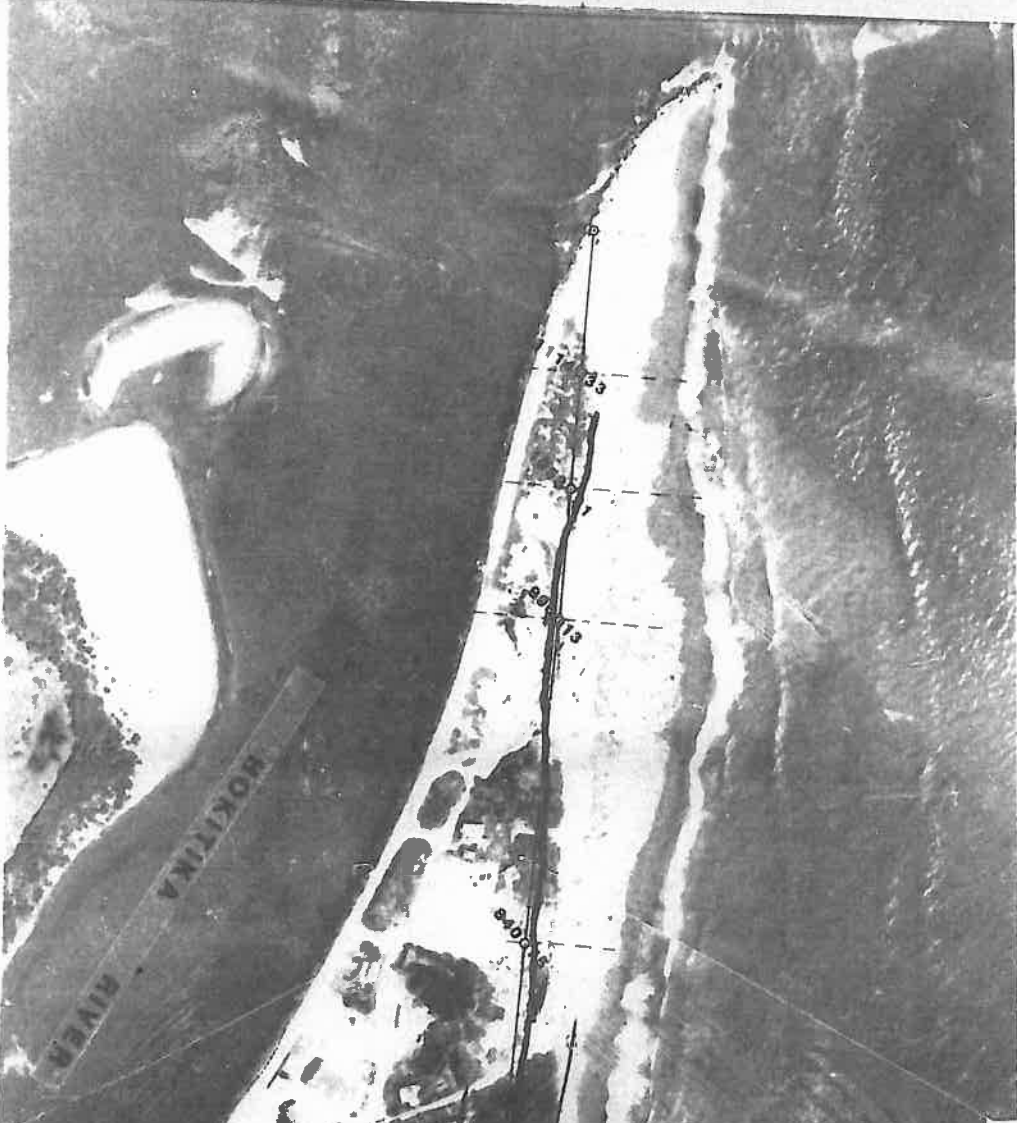

HOKITIKA BEACHFRONT : FROM

HOKITIKA BEACHFRONT : EROSION

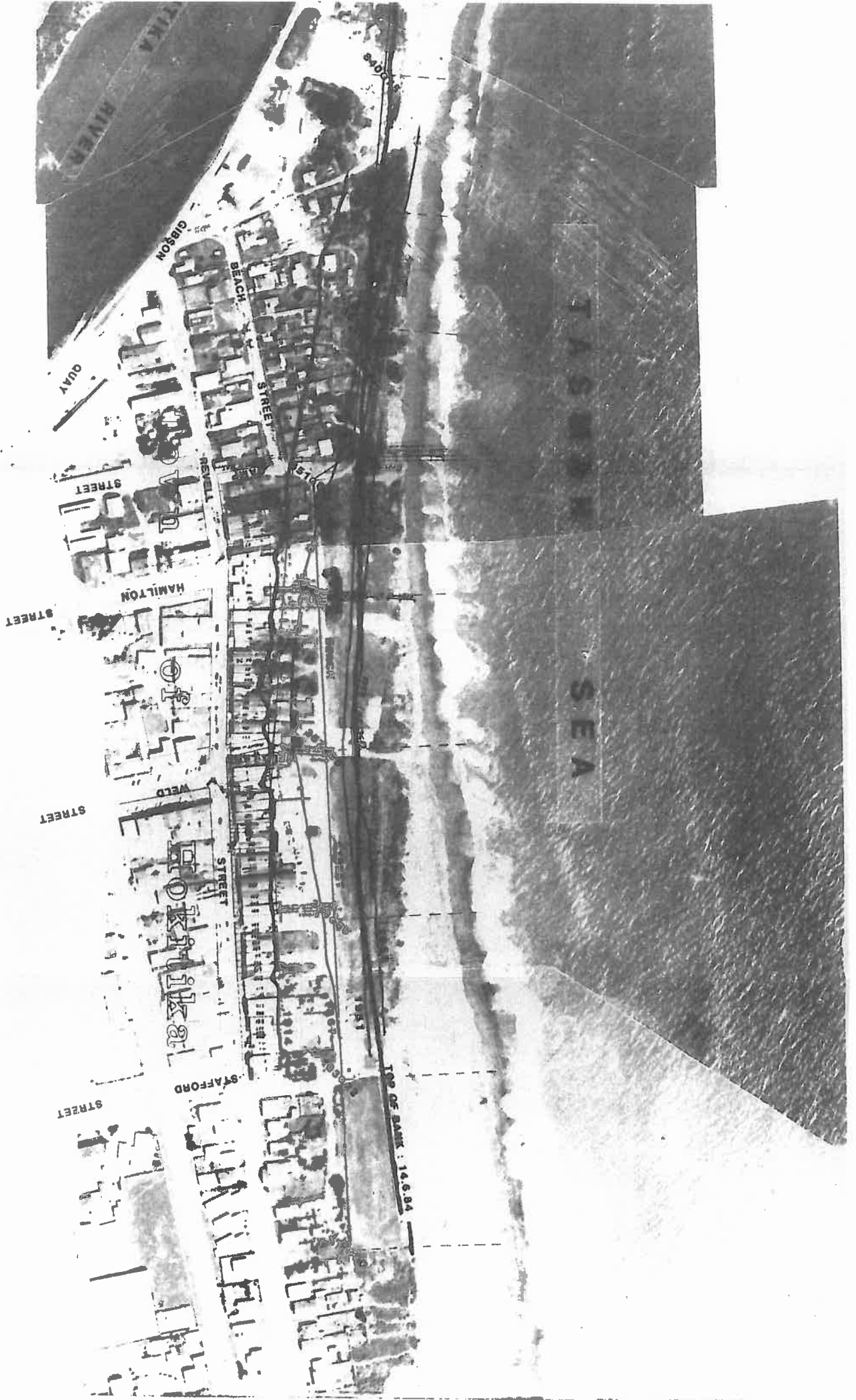

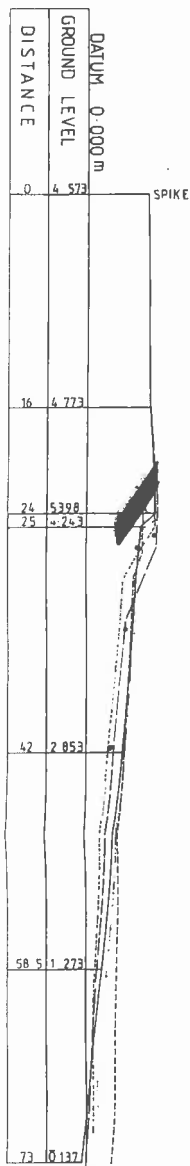
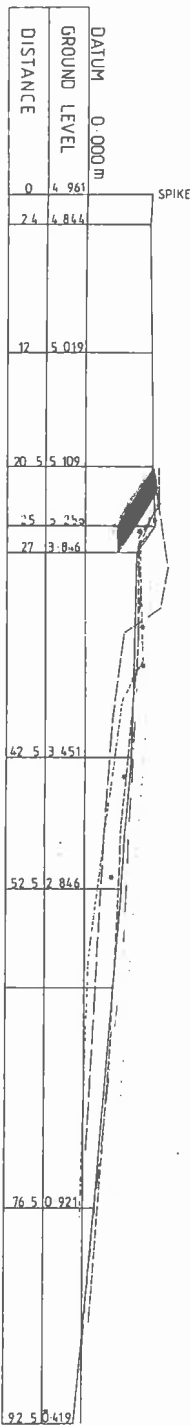
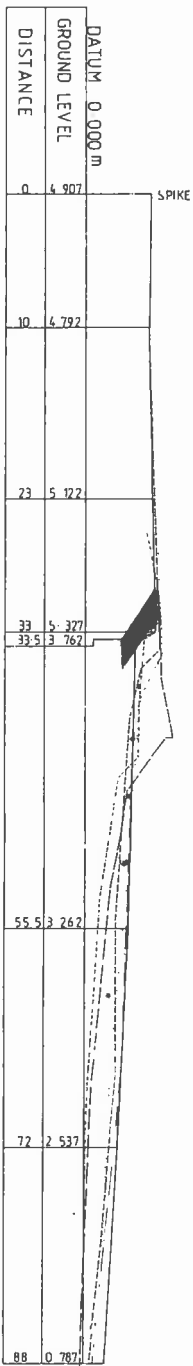
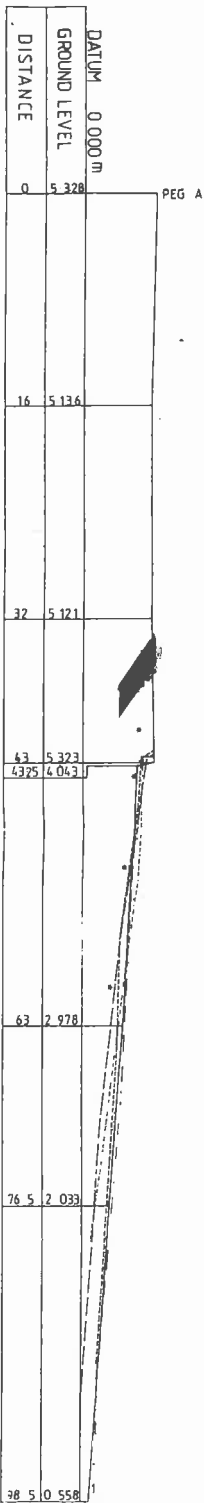

SURVEY

- 18 JUNE 1983
- 13 OCTOBER 1983
- 12 JANUARY 1984
- 20 FEBRUARY 1984
- 9 APRIL 1984
- 14 JUNE 1984
- 19 JULY 1984

APPROVED	DATE	SCALE
DESIGNED		1:200 NATURAL
DRAWN		DW/TUR
CHECKED		LAB
AMENDMENTS		

WESTLAND CATCHMENT BOARD
 \$6000 MOKITKA BEACH FRONTAGE
 LOCATION OF PROPOSED BANK

ENGINEER
 REFERENCE
 L.B. 124, 186,
 172, 173

SHEET 1 OF 3
 No 906/AS
 204

DATUM	0.000 m
GROUND LEVEL	
DISTANCE	

CROSS SECTION 763.63

DATUM	0.000 m
GROUND LEVEL	
DISTANCE	
0	3.969
8	3.599
11	3.624
19	3.834
27	4.644
32	3.699
43	2.229
61	1.039
82	0.229

CROSS SECTION 661.49

DATUM	0.000 m
GROUND LEVEL	
DISTANCE	
0	3.982
12	5.407
17	5.474
24	4.925
24	5.375
26	5.325
37	5.260
46	5.137
65	2.520
83	0.640

CROSS SECTION 573.08

DATUM	0.000 m
GROUND LEVEL	
DISTANCE	

CROSS SECTION 551.63

DATUM	0.000 m
GROUND LEVEL	
DISTANCE	
0	4.452
4	2.437
6	4.262
8	5.477
15	5.452
21	5.462
27	5.169
30	3.537
40	2.442
49	1.392
64	0.008
87	0.618

CROSS SECTION 465.22

POSITION OF EXISTING '1914' PIERS

SURVEY:

- 18 JUNE 1983
- 13 OCTOBER 1983
- 12 JANUARY 1984
- 20 FEBRUARY 1984
- 9 APRIL 1984
- 14 JUNE 1984
- 13 JULY 1984

WESTLAND CATCHMENT BOARD
 906000 HOKITIKA BEACH FRONTAGE
 LOCATION OF PROPOSED BANK

SUNNYT	
DAWAY	
COMPUTING	
TRACED	
CHICRO	
AMENDMENTS	
SCALES	1:200 NATURAL
DATUM	MSL

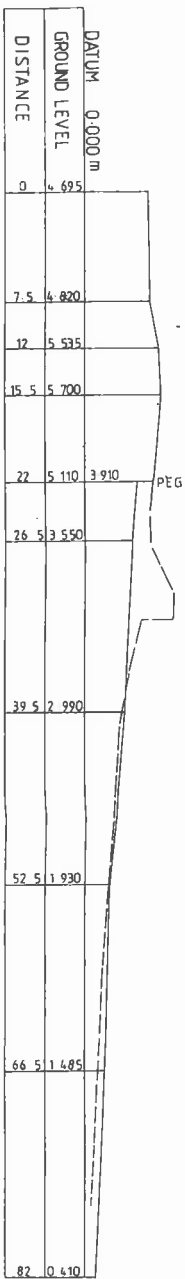

CROSS SECTION 840.75 m

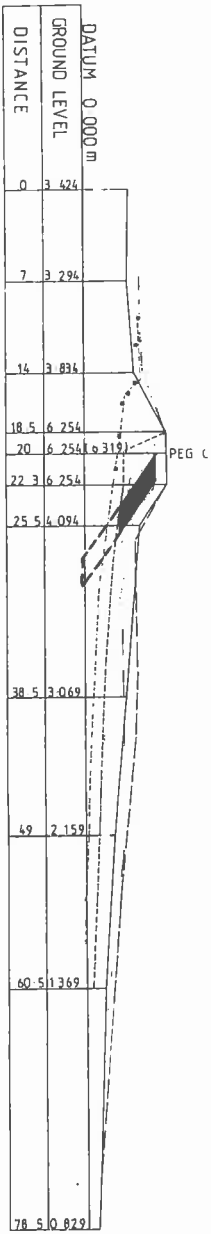

CROSS SECTION 996.13 m





Ministry of Works
and Development

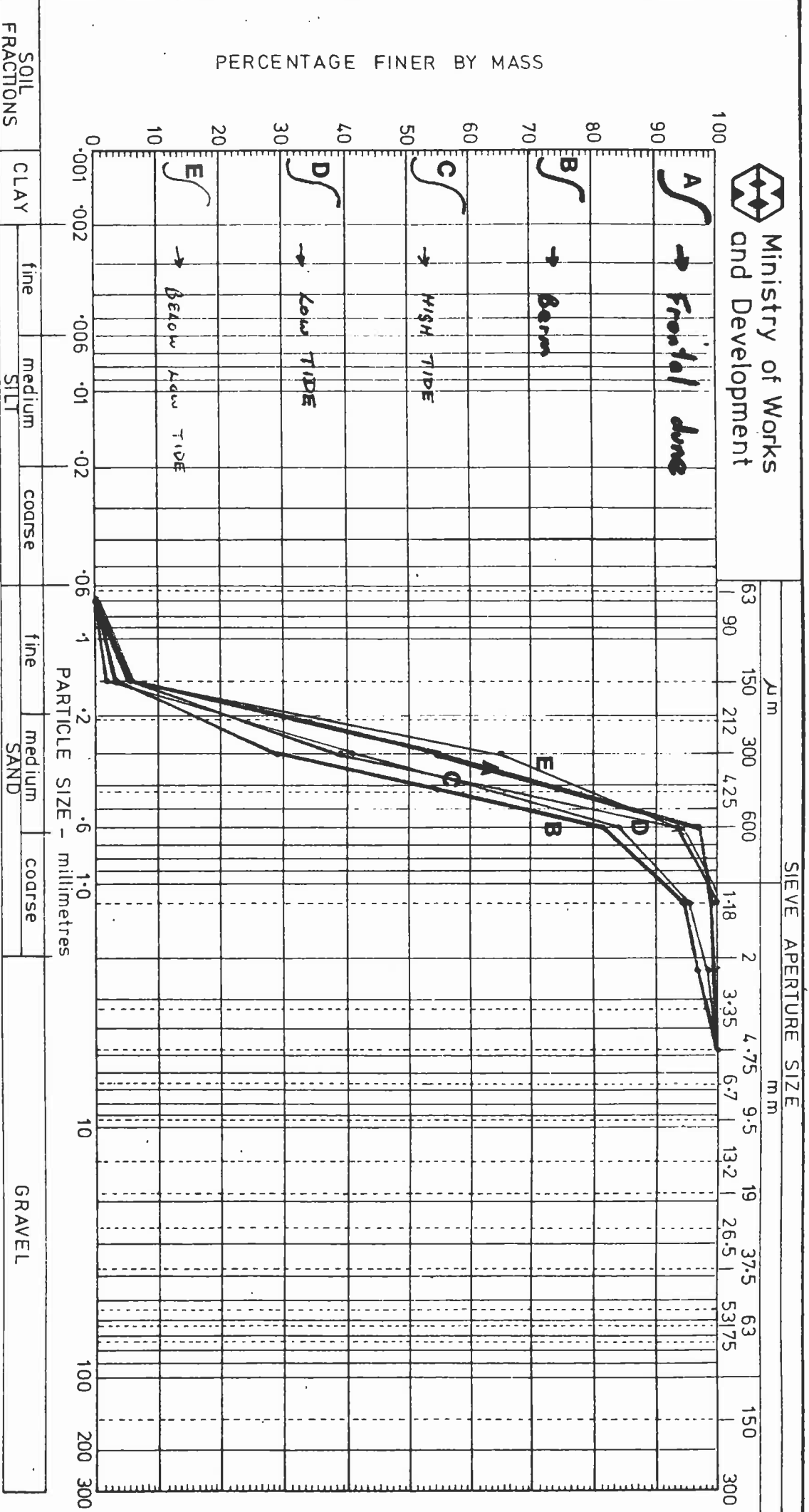

SOIL FRACTIONS: CLAY (fine, medium, coarse), SILT (fine, medium, coarse), SAND (fine, medium, coarse), GRAVEL

JOB: *Wakulla Beach Reservoir* SAMPLE NO. *84/25* DRY SIEVE WET SIEVE

MATERIAL: *Beach Material* HOLE NO. _____ NAME *W. Kumbier* DATE *11-8-84* DRAWING NO. _____

REMARKS: *Small of Wakulla River* DEPTH _____ TEST BY *W. Kumbier* PLOTTED BY *W. Kumbier* CHECK BY _____

DATE: *11-8-84*

PARTICLE SIZE DISTRIBUTION



Ministry of Works
and Development

SIEVE APERTURE SIZE

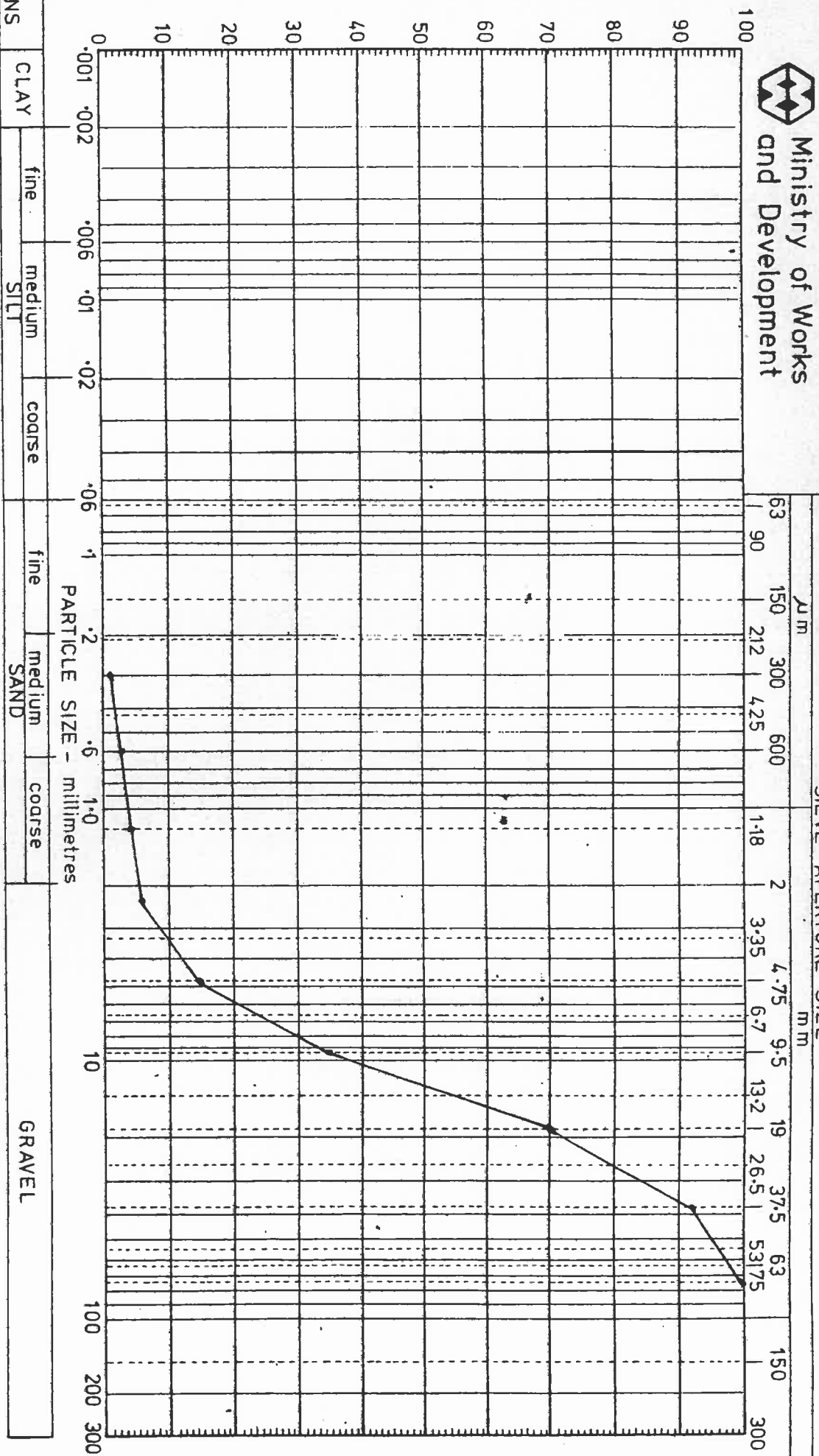

SOIL FRACTIONS	CLAY			SILT			SAND			GRAVEL
	fine	medium	coarse	fine	medium	coarse	fine	medium	coarse	

JOB. *Hekitika Sand Reservoir* SAMPLE NO. *84/25* DRY SIEVE

MATERIAL. *Right Bank of Hekitika River* HOLE NO. WET SIEVE

REMARKS. DEPTH

Test by	NAME	DATE	DRAWING NO.
Plotted by			
Check by			

PARTICLE SIZE DISTRIBUTION



Ministry of Works
and Development

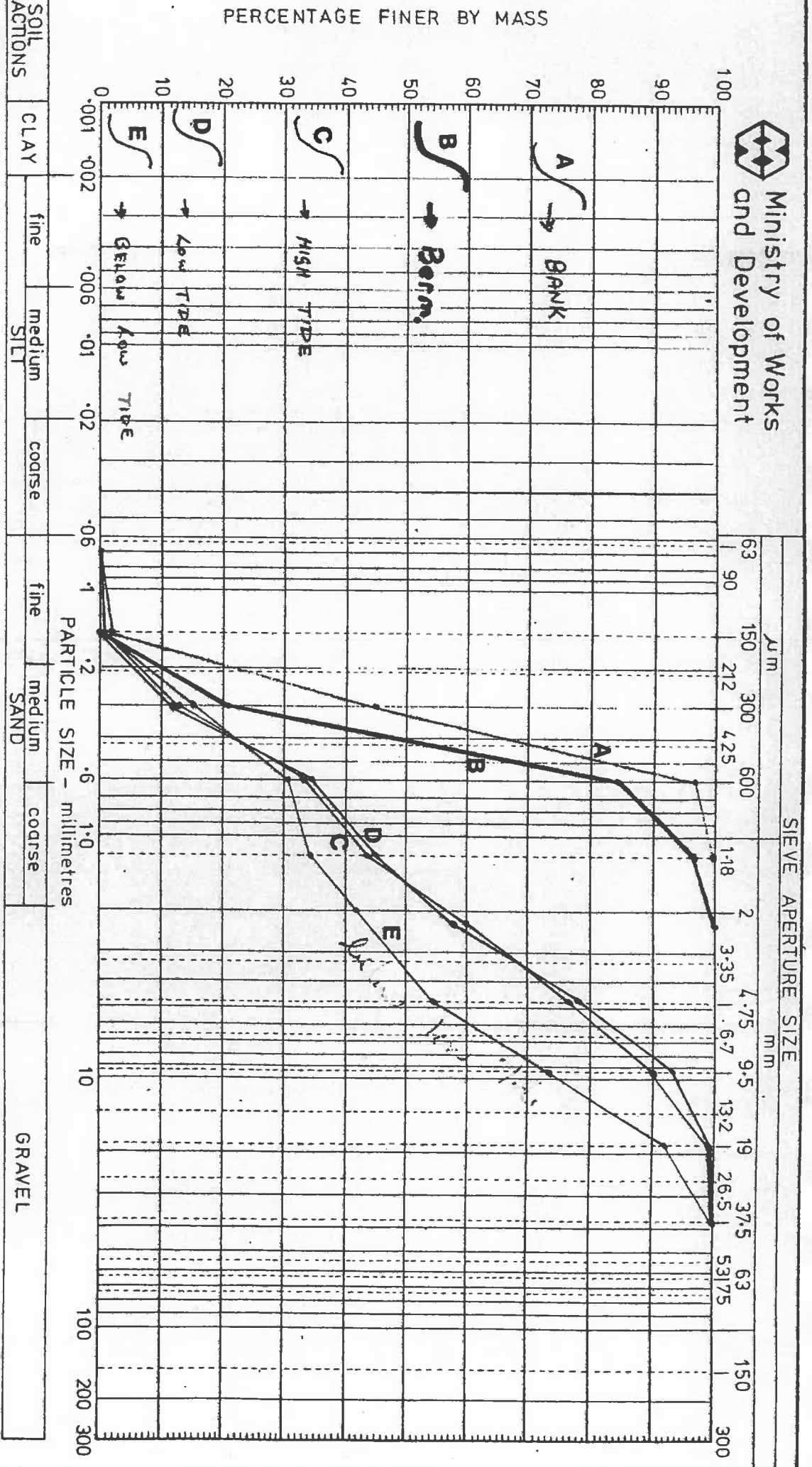



Ministry of Works
and Development

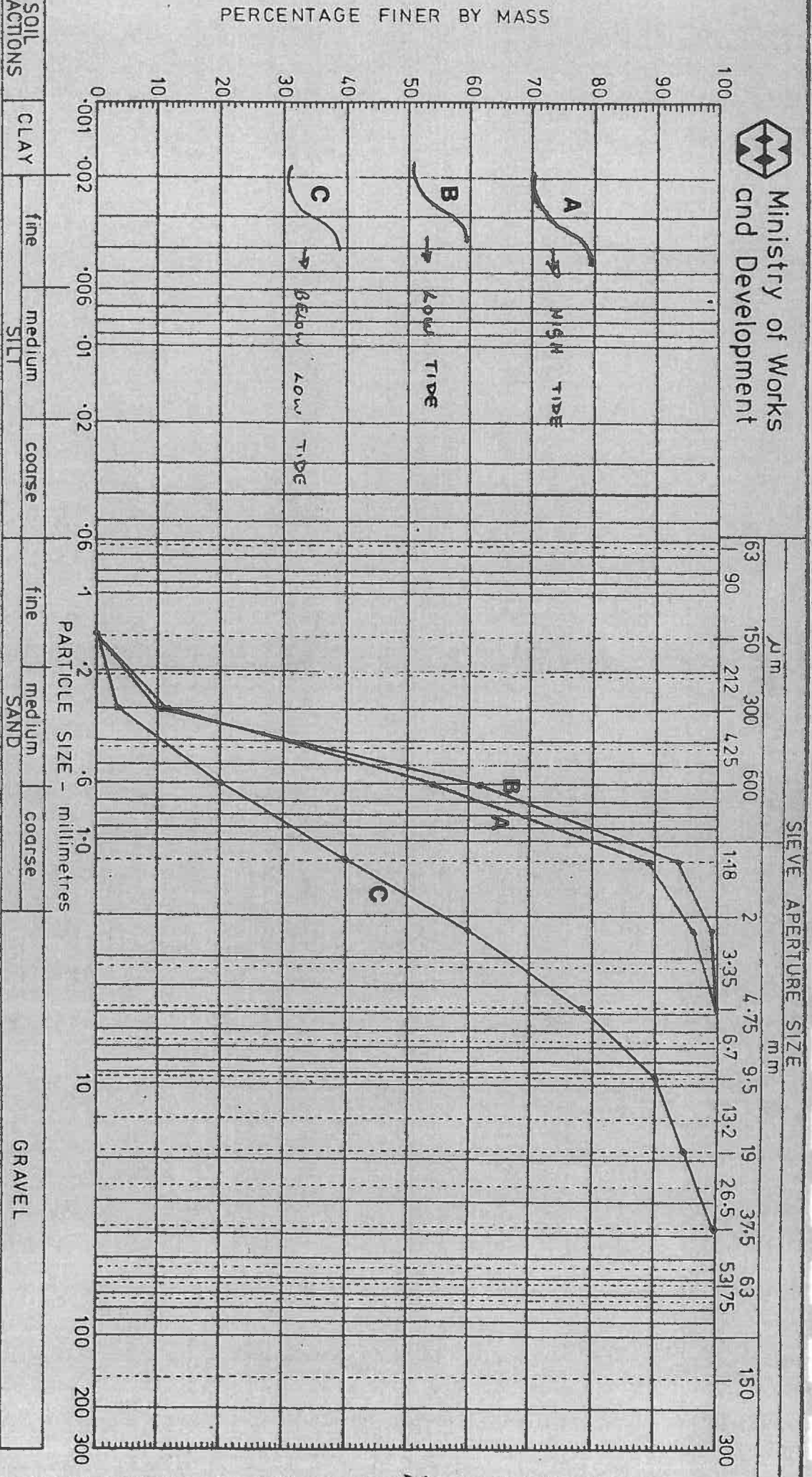

SOIL FRACTIONS: CLAY (fine, medium, coarse), SILT (fine, medium, coarse), SAND (fine, medium, coarse), GRAVEL

JOB: *Mpitiha Beach Reclamation*
 MATERIAL: *Beach Material*
 REMARKS: *North Side*
 SAMPLE NO.: *84/25*
 HOLE NO.:
 DEPTH:
 DRY SIEVE
 WET SIEVE
 NAME: *C. Kumbura*
 DATE: *11-8-84*
 DRAWING NO.:
 Test by: *C. Kumbura*
 Plotted by: *C. Kumbura*
 Check by:

PARTICLE SIZE DISTRIBUTION



Ministry of Works
and Development

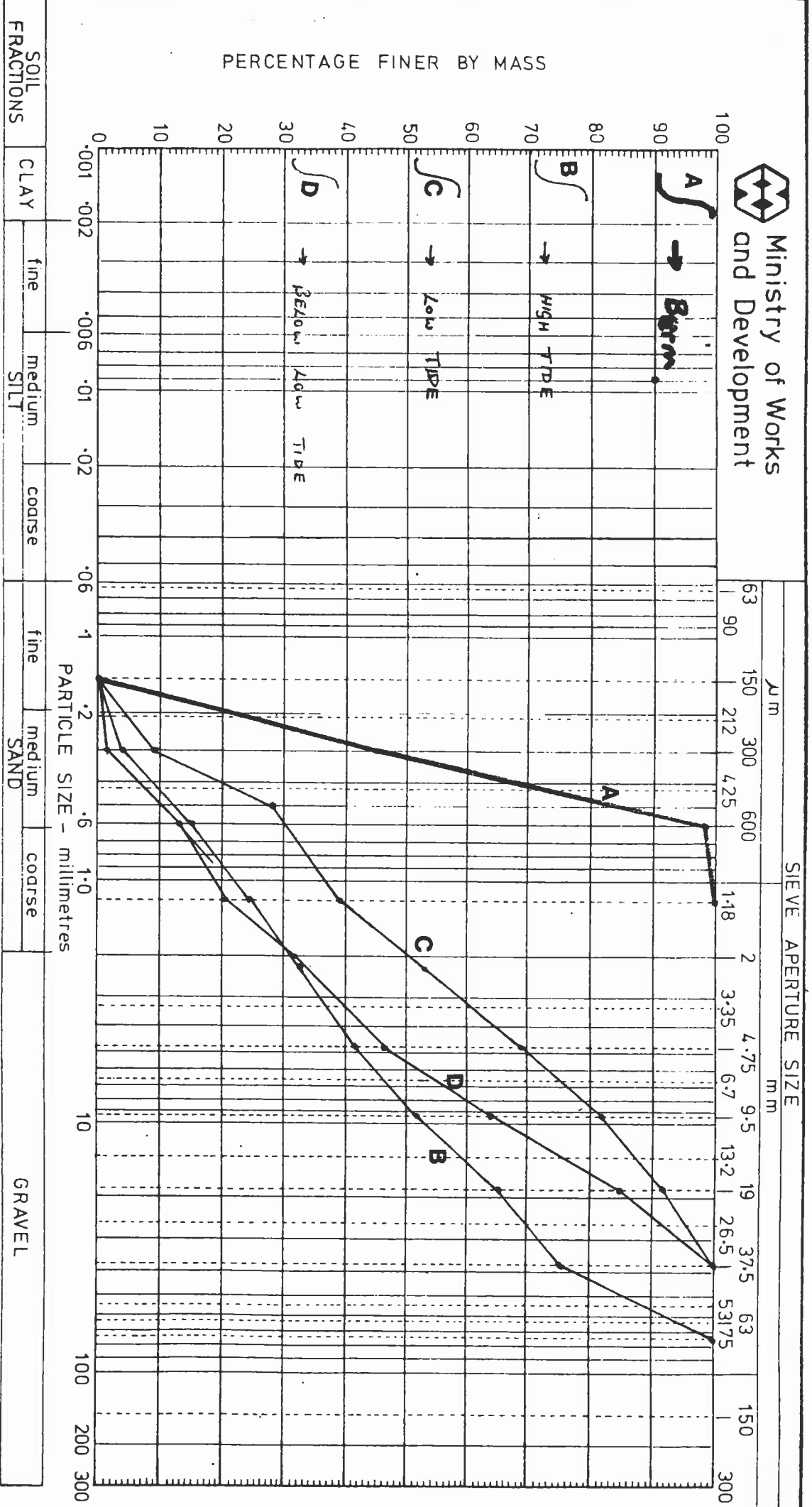

JOB. *Mobilisa Beach Reservoir* SAMPLE NO. *84/25* DRY ~~SIEVE~~ WET SIEVE

MATERIAL. *Beach Material* HOLE NO. _____

REMARKS. *Stiff sand* DEPTH _____

TEST BY *G. Lawrence* NAME *G. Lawrence* DATE *11.8.84* DRAWING NO. _____

PLOTTED BY *G. Lawrence* CHECK BY _____

PARTICLE SIZE DISTRIBUTION